

SIEMENS

SINUMERIK 802D sl plus

Milling

Control system overview
for machine tools' sales people





07/2008

| | |
|-------------------------------------|----|
| Preface | |
| Introduction | 1 |
| System overview | 2 |
| Setup functions | 3 |
| Program management and user memory | 4 |
| Programming | 5 |
| Simulation | 6 |
| 4th axis machining and mold and die | 7 |
| Multilingual operator interface | 8 |
| Maintenance and diagnostics | 9 |
| PC software | 10 |
| Ordering data | 11 |
| Summary of unique selling points | 12 |

Legal information

Warning notice system

This manual contains notices you have to observe in order to ensure your personal safety, as well as to prevent damage to property. The notices referring to your personal safety are highlighted in the manual by a safety alert symbol, notices referring only to property damage have no safety alert symbol. These notices shown below are graded according to the degree of danger.

| |
|--|
|  DANGER |
| indicates that death or severe personal injury will result if proper precautions are not taken. |
|  WARNING |
| indicates that death or severe personal injury may result if proper precautions are not taken. |
|  CAUTION |
| with a safety alert symbol, indicates that minor personal injury can result if proper precautions are not taken. |
| CAUTION |
| without a safety alert symbol, indicates that property damage can result if proper precautions are not taken. |
| NOTICE |
| indicates that an unintended result or situation can occur if the corresponding information is not taken into account. |

If more than one degree of danger is present, the warning notice representing the highest degree of danger will be used. A notice warning of injury to persons with a safety alert symbol may also include a warning relating to property damage.

Qualified Personnel

The device/system may only be set up and used in conjunction with this documentation. Commissioning and operation of a device/system may only be performed by **qualified personnel**. Within the context of the safety notes in this documentation qualified persons are defined as persons who are authorized to commission, ground and label devices, systems and circuits in accordance with established safety practices and standards.

Prescribed Usage

Note the following:

| |
|--|
|  WARNING |
| This device may only be used for the applications described in the catalog or the technical description and only in connection with devices or components from other manufacturers which have been approved or recommended by Siemens. Correct, reliable operation of the product requires proper transport, storage, positioning and assembly as well as careful operation and maintenance. |

Trademarks

All names identified by ® are registered trademarks of the Siemens AG. The remaining trademarks in this publication may be trademarks whose use by third parties for their own purposes could violate the rights of the owner.

Disclaimer of Liability

We have reviewed the contents of this publication to ensure consistency with the hardware and software described. Since variance cannot be precluded entirely, we cannot guarantee full consistency. However, the information in this publication is reviewed regularly and any necessary corrections are included in subsequent editions.

Preface

Scope of validity

This document provides you with an overview of the range of functions included in the **SINUMERIK 802D solution line plus** operator panel controller V1.4 for milling machines.

The document is focusing on vendors and dealers of machine tools.

Organization of the information

- Of the varied functional features of the SINUMERIK products, only those are listed which are of direct value to the machine user.
- All functions contained in the machine's basic configuration will be identified as follows:
 - Basic configuration
- All functions not contained in the machine's basic configuration will be identified as follows:
 - Option: ...
- A summary of the unique selling points of the SINUMERIK 802D sl plus in comparison with competitors may be found in Chapter "Summary of unique selling points".
- For information on marketing options through the machine manufacturer, please see the technical description of each machine.

Subject to change without prior notice

Contact person at machine manufacturer

Marketing & Sales

| | |
|--------|---|
| Phone: | +49 xxx xxx |
| Fax: | +49 xxx xxx |
| Email: | xxx@machinemanufacturer.com |
| Web: | http://www.machinemanufacturer.com |

Service

| | |
|--------|---|
| Phone: | +49 xxx xxx |
| Fax: | +49 xxx xxx |
| Email: | xxx@machinemanufacturer.com |
| Web: | http://www.machinemanufacturer.com |

Homepage:

<http://www.machinemanufacturer.com>

Contact person at Siemens

Sales & Marketing / Technical Consulting

Phone: +49 xxx xxx
Fax: +49 xxx xxx
Web: <http://www4.ad.siemens.de> (worldwide)

Service

Phone: +49 xxx xxx
Fax: +49 xxx xxx
Web: <http://www4.ad.siemens.de> (worldwide)

Homepage:

Visit the JobShop internet portal:
<http://www.siemens.com/jobshop>

Table of contents

| | | |
|----------|---|-----------|
| | Preface | 3 |
| 1 | Introduction..... | 7 |
| | 1.1 Application..... | 7 |
| | 1.2 Machine spectrum..... | 7 |
| 2 | System overview..... | 9 |
| | 2.1 SINUMERIK 802D sl..... | 9 |
| | 2.2 Operator panel | 10 |
| | 2.3 Handheld unit..... | 10 |
| 3 | Setup functions..... | 11 |
| | 3.1 Work offsets | 11 |
| | 3.2 Measure tools..... | 12 |
| | 3.2.1 Measure tools manually in JOG..... | 12 |
| | 3.2.2 Measure tools automatically in JOG | 13 |
| | 3.3 Tool data management | 14 |
| | 3.3.1 Tool list..... | 14 |
| | 3.3.2 Monitoring of tool life and quantity of workpieces..... | 15 |
| | 3.4 Face milling in MDI mode | 16 |
| 4 | Program management and user memory | 17 |
| | 4.1 Program Manager | 17 |
| | 4.2 User memory and data management | 18 |
| | 4.2.1 Buffered CNC user memory..... | 18 |
| | 4.2.2 Compact Flash card..... | 18 |
| | 4.2.3 Slot for USB stick | 19 |
| | 4.2.4 Serial data transfer..... | 19 |
| | 4.2.5 Ethernet networking | 20 |
| 5 | Programming..... | 21 |
| | 5.1 DIN/ISO language..... | 21 |
| | 5.2 DIN/ISO editor..... | 22 |
| | 5.3 Machining Cycles | 23 |
| | 5.4 On-board user manual | 24 |
| | 5.5 On-board pocket calculator..... | 25 |
| | 5.6 Free Contour Programming / Contour Calculator | 26 |
| 6 | Simulation..... | 29 |
| 7 | 4th axis machining and mold and die..... | 31 |
| | 7.1 4th axis machining | 31 |
| | 7.1.1 Overview | 31 |

| | | |
|-----------|--|-----------|
| 7.1.2 | Machining on workpiece periphery (TRACYL)..... | 31 |
| 7.1.3 | 4-axis interpolation | 32 |
| 7.2 | 3-axis mold and die machining | 32 |
| 7.2.1 | Overview | 32 |
| 7.2.2 | Online compressor | 33 |
| 7.2.3 | Jerk limitation | 34 |
| 7.2.4 | Dynamic feedforward control | 35 |
| 7.2.5 | Look Ahead | 36 |
| 7.2.6 | Block search..... | 37 |
| 8 | Multilingual operator interface..... | 39 |
| 8.1 | Multilingual operator interface | 39 |
| 9 | Maintenance and diagnostics | 41 |
| 9.1 | Maintenance-free operation | 41 |
| 9.2 | Diagnostics..... | 42 |
| 9.3 | Remote diagnostics..... | 43 |
| 10 | PC software | 45 |
| 10.1 | CAD reader for PC | 45 |
| 10.2 | SINUMERIK 802D on PC - SinuTrain..... | 46 |
| 10.3 | SINUMERIK 802D self-study CD | 46 |
| 11 | Ordering data..... | 47 |
| 12 | Summary of unique selling points | 49 |
| | Index..... | 51 |

Introduction

1.1 Application

The SINUMERIK 802D sl plus is a customized operator panel controller for standard CNC milling machines and machining centers.

The SINUMERIK 802D sl plus allows you to easily operate machine tools by providing graphical support for all operator control actions.

The functions in JOG (manual) mode enable you to quickly set the machine up for machining, in accordance with your requirements. More specifically, this consists of calculating the workpiece position in the machine, as well as maintaining and measuring the tools in use.

For programming purposes, the SINUMERIK 802D sl plus provides you with a DIN/ISO editor that is easy to operate and has a complete G code in accordance with DIN66025 and ISO dialect. During programming, graphical support is provided for technological machining cycles and contours.

The SINUMERIK 802D sl plus is an efficient, full system, covering all required fields of application without additional setup and training costs:

- Easy-to-use interface for all machine functions
- DIN/ISO programming offline via CAD/CAM system (e.g. mold-making applications)
- DIN/ISO programming on the machine
- Graphical input support for technological machining cycles and contours
- Automatic tool measuring during setup

1.2 Machine spectrum

The SINUMERIK 802D sl plus is particularly recommended for the following machine types:

- Milling machines
- Vertical machining and drilling centers
- Vertical machining centers with an additional rotary table or turning clamp (4th axis)
 - Machining cylindrical workpieces (peripheral surface transformation)
 - Machining on multiple sides (swiveled plane)

System overview

2.1 SINUMERIK 802D sl

The SINUMERIK 802D sl operator panel controller is the ideal package for use with standardized turning and milling machines. Used in conjunction with the new, compact and reliable SINAMICS S120 drive system, the SINUMERIK 802D sl represents a full package for machine tool applications. These range from small and medium batch production to 3-axis mold-making applications.

- Digital drive technology via DRIVE-CLiQ
- Up to 4 interpolating axes and one spindle
- Identical hardware and software for turning and milling
- Powerful PLC based on SIMATIC S7-200 with "ladder logic" programming
- Large, easy-to-read color display



You can find further information in Catalog NC 61

Highlights



- **Powerful and reliable machine equipment from Siemens**
- **Highly dynamic drives and motors**
- **Customized full solution**



SINUMERIK 802D sl
with 10.4 inch TFT color display,
CNC keyboard and machine control panel



Modular
SINAMICS
Drive system



1PH7 spindle motor,
1FK7 servo motors

2.2 Operator panel

The operator panel front consists of an operator panel with a 10.4 inch color TFT display, 8 + 2 horizontal and 8 vertical softkeys, and a CNC keyboard (horizontal or vertical options available). This facilitates clear and user-friendly operation of the machine functions. We also offer the coordinated machine control panel MCP 802D sl with feed and spindle override.



Highlights



- All relevant functions at a glance, thanks to horizontal and vertical softkeys
- Brilliant color display, balanced and high-quality design of operator components
- Easy data handling thanks to the easily accessible Compact Flash card slot on the front

2.3 Handheld unit

For the purpose of setting up the machine, you can install the mini handheld unit pictured below.



Highlight



- Operation as close as possible to the workpiece via a mobile handheld unit

Setup functions

3.1 Work offsets

Basic configuration

Within the SINUMERIK 802D sl plus, the following adjustable work offsets are available:

- A permanently effective basic offset (G500)
- Six other work offsets (G54-G59)

Graphical interface support is provided for the purpose of adjusting workpiece zeros. This means that you can switch directly between the measure workpiece screens and work offset list.

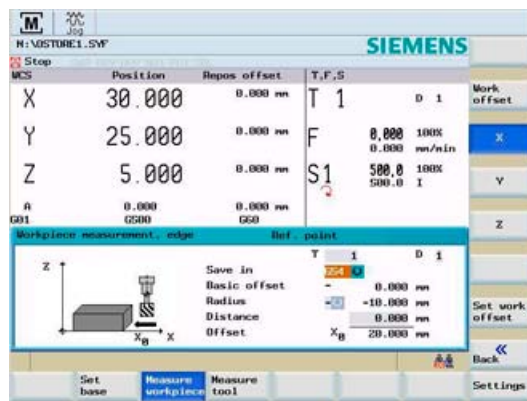

The screenshot shows the 'Work offset' list. It displays the current work offsets for X, Y, and Z axes, along with the tool offsets (X1, Y1, Z1). The 'Work offset' list is as follows:

| Work offset | X | Y | Z | X1 | Y1 | Z1 |
|-------------|---------|-------|-------|-------|-------|-------|
| Base | 0.000 | 0.000 | 0.000 | 0.000 | 0.000 | 0.000 |
| G54 | 450.000 | 0.000 | 0.000 | 0.000 | 0.000 | 0.000 |
| G55 | 0.000 | 0.000 | 0.000 | 0.000 | 0.000 | 0.000 |
| G56 | 0.000 | 0.000 | 0.000 | 0.000 | 0.000 | 0.000 |
| G57 | 0.000 | 0.000 | 0.000 | 0.000 | 0.000 | 0.000 |
| G58 | 0.000 | 0.000 | 0.000 | 0.000 | 0.000 | 0.000 |
| G59 | 0.000 | 0.000 | 0.000 | 0.000 | 0.000 | 0.000 |
| Program | 0.000 | 0.000 | 0.000 | 0.000 | 0.000 | 0.000 |
| Scale | 1.000 | 1.000 | 1.000 | | | |
| Mirror | 0 | 0 | 0 | | | |
| Total | 0.000 | 0.000 | 0.000 | 0.000 | 0.000 | 0.000 |

Highlights



- Easy setup of different workpieces using graphical guidance
- Clear overview of all work offsets

3.2 Measure tools

3.2.1 Measure tools manually in JOG

Basic configuration

The tool compensation values can be directly determined during machine setup. To this end, the SINUMERIK 802D sl plus offers graphical support for measuring tool length and diameter:

- Enter the dimensions by scratching the edge of the workpiece with the tool. The tool offset data is automatically calculated using the position of the tool-carrier reference point and the position of the workpiece edge; the data is then stored in the tool list.
- Tool diameter can be measured in X-axis or Y-axis direction.
- If required, the measurements of a spacer block can be entered directly (X_0 , Y_0 and Z_0).

| WCS | Position | Repos offset | T,F,S |
|-----|----------|--------------|------------------------------|
| X | 0.000 | 0.000 mm | T 1 D 1 |
| Y | 0.000 | 0.000 mm | F 0.000 100% 0.000 mm/min |
| Z | 50.000 | 0.000 mm | S1 500.0 100% 500.0 I |
| A | 0.000 | 0.000 mm | |

Tool measurement manual | Workpiece edge

Distance: 0.000 mm

X_0 : 100.000 mm ABS

Y_0 : 0.000 mm ABS

Diameter: 20.000 mm

Buttons: Set base, Measure workpiece, Measure tool, Back, Settings

Highlight



- Save time during tool setup by seeing exactly what you are doing.

3.2.2 Measure tools automatically in JOG

Basic configuration

In JOG mode, you can automatically determine the tool compensation values for the length and diameter in the machine. To this end, the SINUMERIK 802D sl plus offers graphical support for automatic measuring and for calibrating the tool probe.

- To measure the tool diameter and length, simply move the tool near the probe.
- Click "Start". When the probe detects the tool, the controller automatically calculates the tool geometry.

The screenshot shows the SINUMERIK control interface in JOG mode. At the top, it indicates 'Tool measurement active' and 'SIEMENS'. Below this is a table for tool data:

| WCS | Position | Repos offset | T,F,S |
|-----|----------|--------------|--------------|
| X | 0.000 | 0.000 mm | T 1 |
| Y | 0.000 | 0.000 mm | F 0.000 100% |
| Z | 50.000 | 0.000 mm | S1 0.0 100% |
| A | 0.000 | 0.000 mm | |
| G01 | G500 | G60 | |

Below the table, the 'Tool measurement auto' section shows a graphical representation of the tool and probe. The tool number is T 1 G 17 D 1. The measured length is 100.000 mm. The interface includes buttons for 'Set base', 'Measure workpiece', 'Measure tool', and 'Settings'.

Highlight



- Speedy and precise tool measuring is standard
- Pre-installed graphic support for measuring with tool probe

3.3 Tool data management

3.3.1 Tool list

Basic configuration

| Type | T | D ₂ | Geometry | | Wear | |
|------|----|----------------|----------|--------|---------|--------|
| | | | Length1 | Radius | Length1 | Radius |
| ✓ | 1 | 1 | 100.000 | 10.000 | 0.000 | 0.000 |
| ✓ | 2 | 1 | 100.000 | 20.000 | 0.000 | 0.000 |
| ✓ | 3 | 1 | 100.000 | 20.000 | 0.000 | 0.000 |
| ✓ | 4 | 1 | 160.000 | 31.500 | 0.000 | 0.000 |
| ✓ | 5 | 1 | 80.000 | 20.000 | 0.000 | 0.000 |
| ✓ | 6 | 1 | 80.000 | 20.000 | 0.000 | 0.000 |
| ✓ | 7 | 1 | 100.000 | 31.500 | 0.000 | 0.000 |
| ✓ | 8 | 1 | 120.000 | 31.500 | 0.000 | 0.000 |
| ✓ | 9 | 1 | 80.000 | 4.000 | 0.000 | 0.000 |
| ✓ | 10 | 1 | 100.000 | 5.000 | 0.000 | 0.000 |
| ✓ | 11 | 1 | 100.000 | 6.000 | 0.000 | 0.000 |
| ✓ | 12 | 1 | 100.000 | 6.000 | 0.000 | 0.000 |

For the purpose of managing tools, the SINUMERIK 802D sl plus provides you with an easy-to-use tool list, which displays all relevant tool data and wear.

- In the tool list, you can create and delete tools using softkeys.
- For each tool, you can store the following data:
 - Special icon for the individual tool type with direction of tool orientation (mill or drill)
 - Tools are displayed in the list with a number, e.g. T1.
 - Number of the compensation block for the tool cutting edge, e.g. D1
 - Tool offset data in the form of length and radius
 - Values for geometry and wear in a single table
- Using individual password protection, you can specify the maximum permissible input values for tool wear to avoid collisions, for example. This can be done using display machine data MD 208, MD 209 and MD 374.

Highlight



- All tool data at a glance
- More safety in managing tool data

3.3.2 Monitoring of tool life and quantity of workpieces

Basic configuration

| Type | T | Tool life (min) | | | | Quantity | | | |
|------|---|-----------------|---------|--------|-------------------------------------|----------|---------|--------|-------------------------------------|
| | | Setpt. | Prev.lt | Resid. | Activ | Setpt. | Prev.lt | Resid. | Activ |
| 1 | 1 | 100.000 | 10.000 | 99.974 | <input checked="" type="checkbox"/> | 50 | 5 | 50 | <input checked="" type="checkbox"/> |
| 2 | 1 | 0.000 | 0.000 | 0.000 | <input type="checkbox"/> | 0 | 0 | 0 | <input type="checkbox"/> |
| 3 | 1 | 0.000 | 0.000 | 0.000 | <input type="checkbox"/> | 0 | 0 | 0 | <input type="checkbox"/> |
| 4 | 1 | 0.000 | 0.000 | 0.000 | <input type="checkbox"/> | 0 | 0 | 0 | <input type="checkbox"/> |
| 5 | 1 | 0.000 | 0.000 | 0.000 | <input type="checkbox"/> | 0 | 0 | 0 | <input type="checkbox"/> |
| 6 | 1 | 0.000 | 0.000 | 0.000 | <input type="checkbox"/> | 0 | 0 | 0 | <input type="checkbox"/> |
| 7 | 1 | 0.000 | 0.000 | 0.000 | <input type="checkbox"/> | 0 | 0 | 0 | <input type="checkbox"/> |
| 8 | 1 | 0.000 | 0.000 | 0.000 | <input type="checkbox"/> | 0 | 0 | 0 | <input type="checkbox"/> |
| 9 | 1 | 0.000 | 0.000 | 0.000 | <input type="checkbox"/> | 0 | 0 | 0 | <input type="checkbox"/> |
| 10 | 1 | 0.000 | 0.000 | 0.000 | <input type="checkbox"/> | 0 | 0 | 0 | <input type="checkbox"/> |
| 11 | 1 | 0.000 | 0.000 | 0.000 | <input type="checkbox"/> | 0 | 0 | 0 | <input type="checkbox"/> |
| 12 | 1 | 0.000 | 0.000 | 0.000 | <input type="checkbox"/> | 0 | 0 | 0 | <input type="checkbox"/> |

The SINUMERIK 802D sl plus offers automatic tool monitoring.

- You can monitor tool wear by observing tool life and/or workpiece quantity. If a tool reaches its wear limit, an alarm is given automatically and the tool is suspended from further machining.
- You can specify the following data in tool monitoring:
 - Tool life, specified as a setpoint, and prewarning limit for tool monitoring. The time remaining before the tool is deactivated is calculated and displayed.
 - Workpiece quantity, specified as a setpoint, and prewarning limit for tool monitoring. The workpiece quantity remaining before the tool is deactivated is calculated and displayed.
 - Tool monitoring can be activated for tool life and/or quantity of workpieces.
- When tool life monitoring is activated, tool life is monitored during the tool's operation time (G1, G2, G3). Workpiece quantity is monitored using a program command at the end of the part program, usually Setpiece(1).

Highlight



- Efficient monitoring of tool life and workpiece quantity is standard

3.4 Face milling in MDI mode

Basic configuration

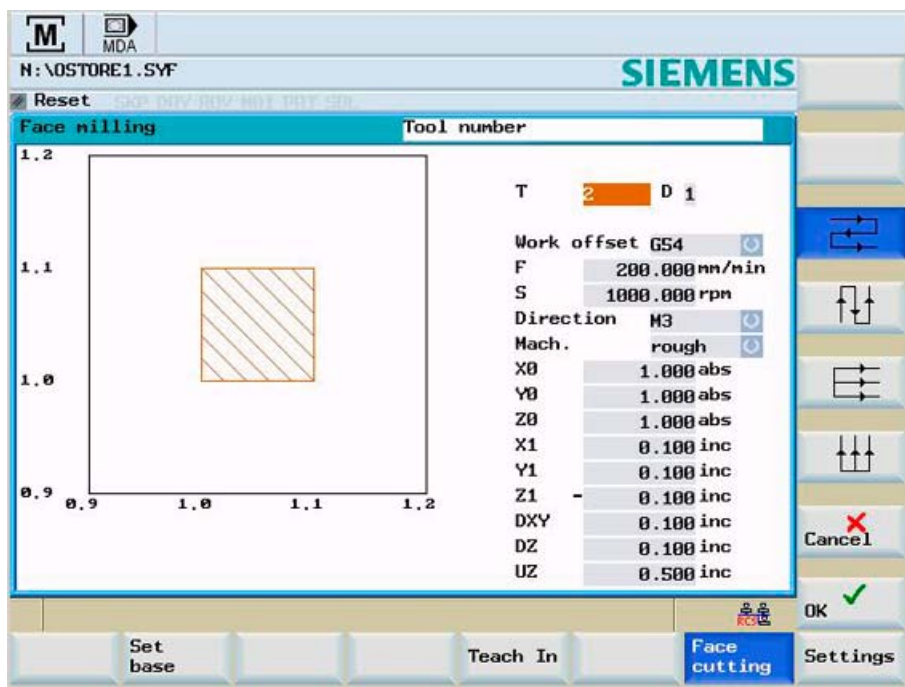

When preparing a blank workpiece, SINUMERIK 802D sl plus supports you in the following ways:

- Input of machining parameters by dialog, complete with tool, work offset, feedrate, spindle speed and direction
- Selection of the machining strategy via softkey
- There is no need for programmers to write the part programs themselves. After entering the machining parameters, press OK and the program will be created automatically.
- The MDI blocks are also retained after NC Start and can be saved as a part program.

Highlight



- Speedy preparation of the blank workpiece

Program management and user memory

4.1 Program Manager

Basic configuration

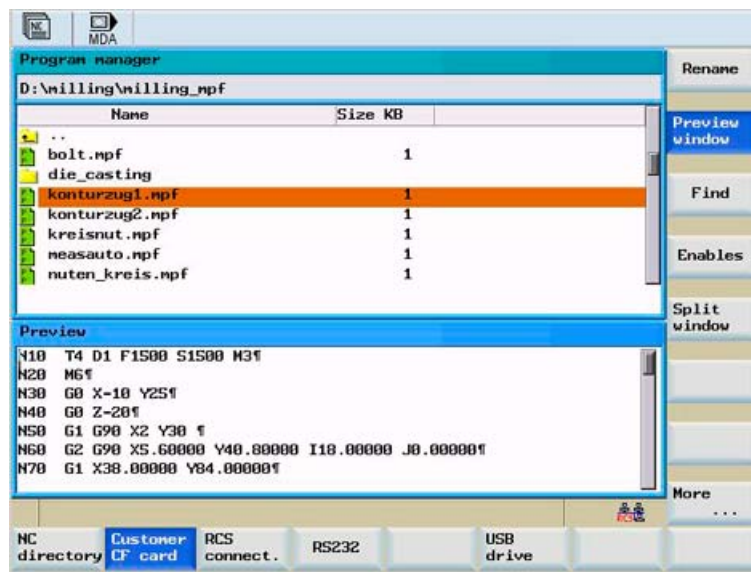

Using the SINUMERIK 802D sl plus Program Manager, you can easily manage your part programs.

- PC-like functions, e.g. Mark, Copy, Paste, and Rename
- File names for part programs can be entered in clear text, making them easy to identify (max. 25 characters).
- Clear structures with subdirectories on several levels
- Quick search function based on entry of the 1st letter of the program name. The controller automatically positions the cursor on a program with the initial letter matching that which was entered.
- Preview of the first seven lines of the part program before editing
- All part programs available on the machine, thanks to the 1 MB user memory
- Access to shared network drives and sharing of directories for remote access via Ethernet networking

Highlights



- **Better overview with clear-text file names**
- **User-friendly data handling in typical PC style with copy, paste, rename, etc.**

4.2 User memory and data management

4.2.1 Buffered CNC user memory

Basic configuration

SINUMERIK 802D sl plus

1 MB

Management of up to 100 part programs. For larger quantities, we recommend that part programs be managed using the CF card.

Highlight



- Large memory space included in scope of delivery

4.2.2 Compact Flash card

Basic configuration, only
CompactFlash card required

A CompactFlash card slot is located directly at the operator panel front of the SINUMERIK 802D sl.

- Card can be inserted or removed during operation, i.e., the machine does not have to be restarted in order for the CompactFlash card to be recognized.
- Cover can be closed while the card is inserted in order to protect the unit from dust.
- Load and execute part programs from the CompactFlash card
- No loss in speed during execution of part programs from the CompactFlash card (DNC operation)
- No special software necessary for reading/writing CompactFlash cards via PC



Part programs on the CompactFlash card are not edited via controller, but rather via PC.

Highlight



- Efficient and reliable solution for handling a large volume of user data

4.2.3 Slot for USB stick

- ☑ Basic configuration, only USB stick required

In the SINUMERIK 802D sl, a slot is reserved for a USB stick.

- USB stick can be inserted or removed during operation, i.e., the machine does not have to be restarted in order for the USB stick to be recognized.
- Load and execute part programs from the USB stick
- No loss in speed during execution of part programs from the USB stick (DNC operation)
- No special software necessary for reading/writing the USB stick via PC



Part programs on the USB stick are not edited via controller, but rather via PC.

Highlight



- **Efficient and reliable solution for handling a large volume of user data**
- **Freedom in the selection of the mass storage device**

4.2.4 Serial data transfer

- ☑ Basic configuration, installation of RCS802 tool on PC (included on Toolbox CD as standard)

The SINUMERIK 802D sl plus facilitates easy data transfer from and to PCs via the RS232 interface. To do this, install the RCS802 tool on your PC.

- Backing up of machine data
- Archive/series startup file
- Backing up of part program data



Note: If you have not received the Toolbox CD, please consult your machine OEM.

Highlight



- **Easy data transfer with a proven track record**

4.2.5 Ethernet networking

☑ SINUMERIK 802D sl pro

The SINUMERIK 802D sl pro is set up for Ethernet (TCP/IP) networking (RJ45 connection).

- The data transfer rate is 10/100 Mbps.
- Remote access to the controller via the RCS802 tool, e.g. for setup and remote diagnostics (PC license required)
- Access to the network drives is available directly from the program manager. No additional software is required on the server.

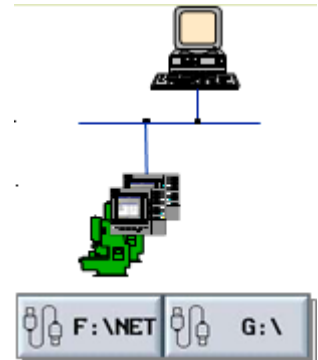

Highlight



- **Easy and economical connection via Ethernet (TCP/IP) to Windows PCs or Unix workstations**

Programming

5.1 DIN/ISO language

☑ Basic configuration

For DIN/ISO programming purposes, the SINUMERIK 802D sl plus offers a large pool of commands which are oriented towards the task at hand:

- G-code according to DIN66025 and in ISO dialect mode
- G-functions and extended G-functions
Powerful commands, e.g. CIP for circular interpolation via intermediate point
- Unlimited number of programmable work offsets
Using the commands TRANS, SCALE, MIRROR, ROT, you can shift, scale, mirror, and rotate the workpiece coordinate system as required.
- Calculation operations and logic operations of variables
These calculation operations include, e.g.: +, -, *, /, sin, cos, exp, ==, <>
- User data
You can freely define variables in the part program using names (clear text) and type (LUDs, no GUDs).
- R parameters (calculation parameters)
300 predefined R parameters are available as flexible calculation variables (floating point format).
- System variables
Access from the program to, for example, tool offsets, axis positions and measuring values
- Program control structures
Language commands such as IF and GOTO are available for programming with conditions and loops.

Highlight



- Unbeatable pool of commands for flexible and time-optimized part programs

5.2 DIN/ISO editor

Basic configuration

For programming purposes, the SINUMERIK 802D sl plus has a text-based DIN/ISO editor. This allows you to directly enter or change CNC language commands, meaning that you have access to the entire range of CNC functions.

The editor offers the following range of functions:

- Easy-to-use program entry with Copy, Paste, Search/Replace, Numbering, etc.
- Graphics editor for creating workpiece contours entered in the program as G-code
- Standard machining cycles for drilling and milling
- Simulation of the program created
- Recompile of program cycles for further editing in the graphical interface
- Direct execution from any NC program block (block search)

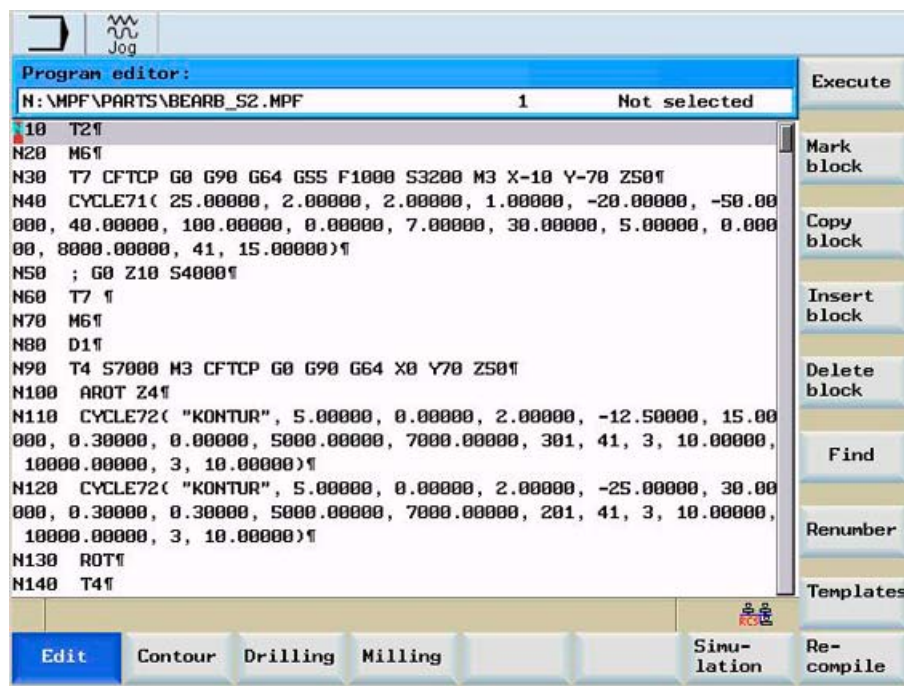

Highlight



- Save time by programming with efficient DIN/ISO editor

5.3 Machining Cycles

Basic configuration

In the case of recurring machining operations, the SINUMERIK 802D sl plus provides you with graphical support for the following technology canned cycles. You can parameterize these and assemble them for the program in any way you wish.

- Milling
 - Face milling
 - Contour milling
 - Rectangular pocket and spigot, circular pocket and spigot
 - Elongated holes on a circle, slots on a circle, circumferential slots
 - Thread milling (inside and outside)
- Drilling
 - Centering, drilling, counter-boring, reaming, deep-hole drilling, tapping
 - Repetition of hole machining using hole patterns row/circle (MCALL)

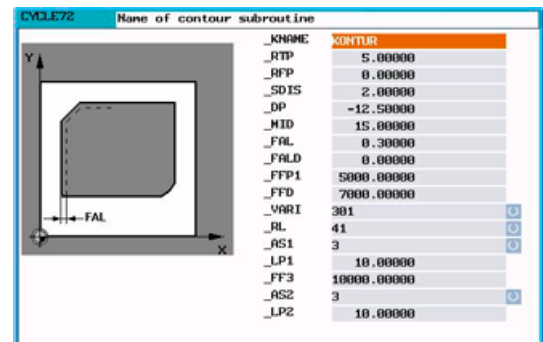

Comprehensive functional and graphical support is provided:

- During parameterization, support is provided by the clear pictures and infotexts accompanying the parameters, e.g. finishing allowance in depth.
- A comprehensive range of choices is available for effective machining, such as helical insertion for rectangular and circular pockets.
- Thread milling, including helical interpolation of all three geometry axes X, Y and Z, is contained within the basic configuration.

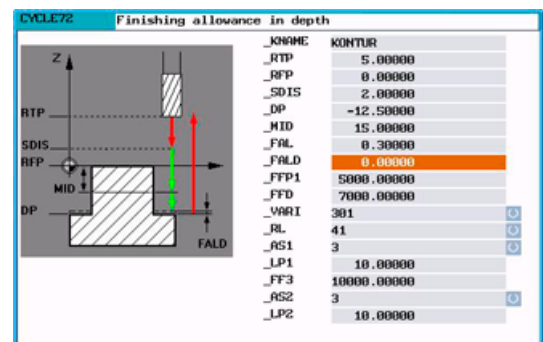

Highlight



- Graphical cycle support helps you create your part program faster
- Highly flexible G-code programming extended by graphical cycles

5.4 On-board user manual

Basic configuration

The on-board user manual provides descriptions of all important operator functions. In addition, it provides a complete description of NC commands, cycle programming and drive alarms (as can be found in the paper documentation).

You can call up the Help menu in the following ways:

- Pressing the Help key on the CNC keyboard to call up the table of contents
- Pressing the Help key to call up the context-sensitive help system, e.g. when the cursor is at a cycle parameter. Help is immediately opened at the relevant place.

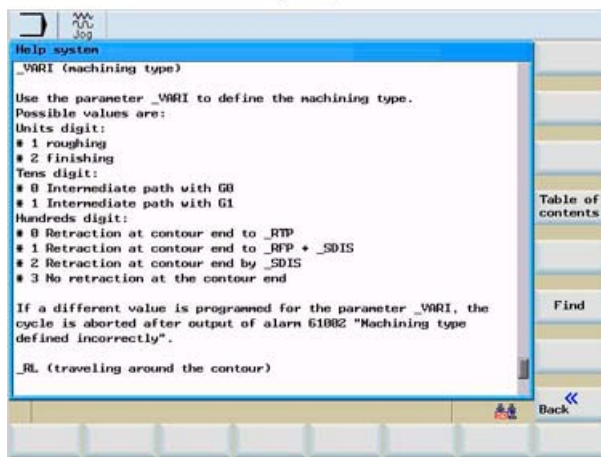
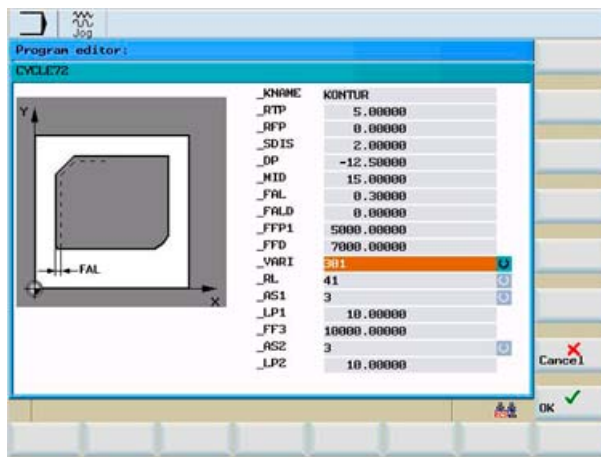

Highlight



- Never lose time again because you don't have the user manual at hand

5.5 On-board pocket calculator

Basic configuration

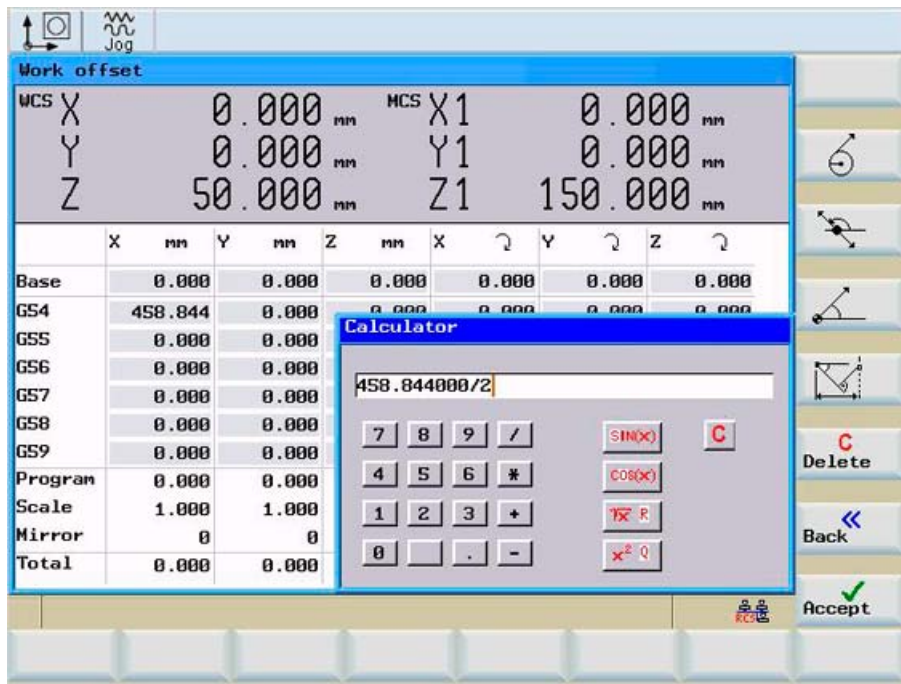

The integrated pocket calculator offers the following range of functions:

- Callable from any operating area
- Take over a value from an input field and write it back after calculation
- Four basic calculation operations, as well as sine, cosine, square, and square root functions
- Bracket function for calculating nested terms
- Functions for calculating construction points on a contour, e.g.:
 - Tangential transition between a circle sector and a straight line
 - Converting polar coordinates to Cartesian coordinates
- By pressing the input key, you can see the result of a calculation before you confirm it with the accept softkey.

Highlight



- More certainty for operating and programming thanks to integrated pocket calculator - no more calculation or typing mistakes

5.6 Free Contour Programming / Contour Calculator

Basic configuration

The SINUMERIK 802D sl supports you in free programming, from simple to complex contours. Free contour programming is a support tool for the DIN/ISO editor. Programs can be decompiled in the program editor and can thus be revised in the contour calculator.

You can include the following contour elements and parameterize them in screen forms:

- Straight line in the X direction
- Straight line in the Y direction
- Oblique line in the X/Y direction. You can enter the end point of the straight line using coordinates or an angle.
- Arc with any direction of rotation.

Additional screen forms enable you to determine the starting point and to close the contour.

The contour calculator supports you in programming the following functions, among others:

- Calculation of only partly determined elements, as soon as the missing parameters can be derived from parameters already known, e.g. geometry data missing in the parts drawing.
- Chaining of contour elements.
- Insert radius or chamfer between two contour elements.
- Transfer of the programmed contours to the edited part program.
- It is possible to delete and insert contour elements at a later stage

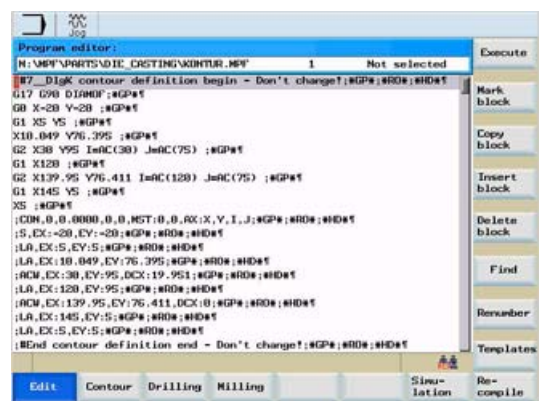
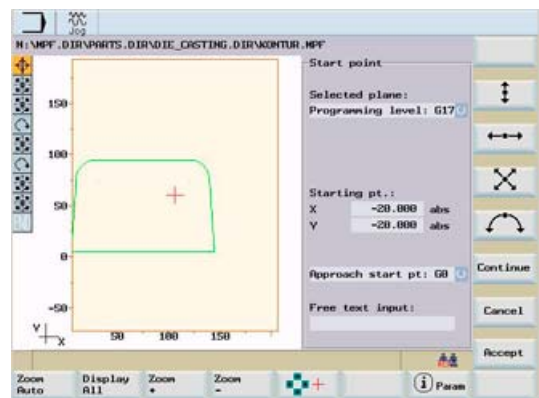

The following functions make work with the contour calculator easier:



When you select this softkey, you can use the cursor keys to determine a picture detail that is to be enlarged.

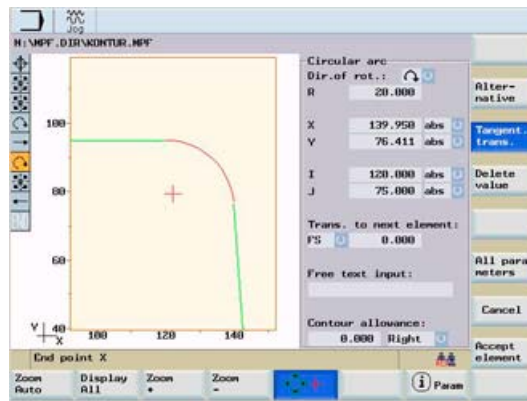

After selection of this softkey, graphical help screens will be displayed in addition to the relevant parameters.

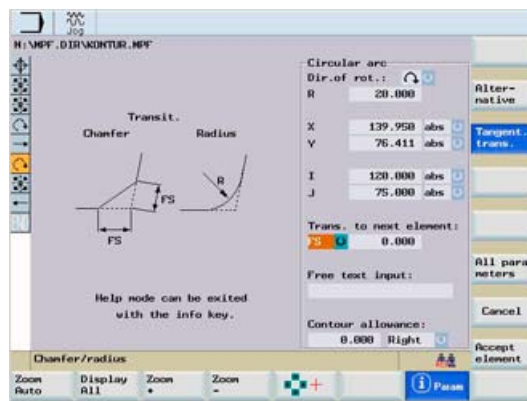

Highlight



- Fast and safe - from the drawing to the finished workpiece
- Program recompilation for further editing in the contour calculator
- Easy input of the workpiece geometry: "Drawing dot for dot" like in ShopMill

Simulation

Basic configuration

The SINUMERIK 802D sl plus offers you high process safety through integrated simulation, since it enables you to verify part programs before they are executed. By using broken-line graphics, you can trace the programmed tool path.

- Clear overview through use of different colors
 - Rapid feedrate = red
 - Cutting feedrate = blue
- Quickly display simulation result by activating dry run feedrate (used instead of the programmed cutting feedrate)
- Possibility of zooming into details at any time during and after simulation
- Display the entire workpiece using the Zoom Auto softkey

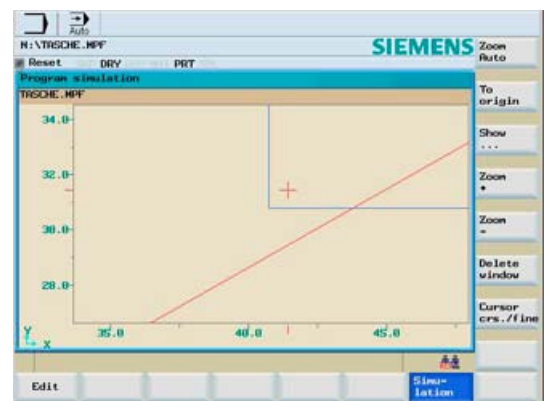
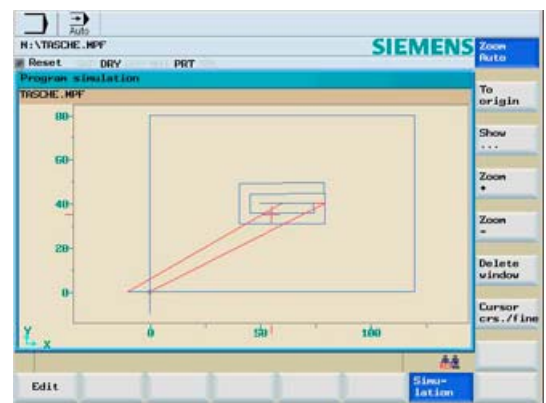

Highlight



- More process safety through effective simulation

4th axis machining and mold and die

7.1 4th axis machining

7.1.1 Overview

The SINUMERIK 802D sl plus provides you with a comprehensive range of functions for machining centers with a rotary table or dividing unit. This includes:

- Clamping several workpieces to a dividing unit / turning clamp
- Clamping a workpiece to a rotary table
- 4-axis part programs from CAD-CAM systems

Highlight



- Machining of complex workpieces with standard package possible

7.1.2 Machining on workpiece periphery (TRACYL)

Basic configuration

The TRACYL transformation is used for machining the peripheries of cylindrical bodies, e.g. for milling slots. When using TRACYL, the milling machine must have an additional, appropriate rotary axis (which can be interpolated with other axes) at its disposal, e.g. a rotary table or a dividing unit.

- The groove path is programmed on the level surface of the cylinder which is to be machined.
- TRACYL transforms the programmed traversing movements in the Cartesian coordinate X, Y, Z system into the movements of the real machine axes (linear and rotary axes).

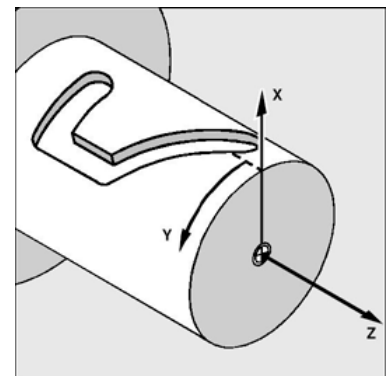

Highlight



- Easy-to-use workpiece periphery programming is standard

7.1.3 4-axis interpolation

Basic configuration

The SINUMERIK 802D sl plus supports 4th axis machining, e.g. for rotary tables and swiveling tables.

Using the program command FGROUP, all 4 axes can be interpolated, e.g. FGROUP (X, Y, Z, A).

Highlight



- 4-axis interpolation is standard

7.2 3-axis mold and die machining

7.2.1 Overview

The SINUMERIK 802D sl plus provides the best conditions for mold-making applications:

The advanced technology of the SINUMERIK 840D is also available in the SINUMERIK 802D sl plus, e.g.:

- Jerk limitations separated by rapid traverse / feed
- Following error compensation (feedforward control)
- 100 blocks Look Ahead
- Online compressor
- Large mold-making programs can be transferred and directly executed via CompactFlash card, USB stick or Ethernet.



Highlight



- Machining of mold-making workpieces is already standard

7.2.2 Online compressor

Basic configuration

Freeform programs in G01 format are converted to the internal control spline format during NC runtime. The number of traversing blocks is thereby drastically reduced.

With an active compressor, free-form surfaces can be machined at a higher speed and without reaching the block change limit.

Example:

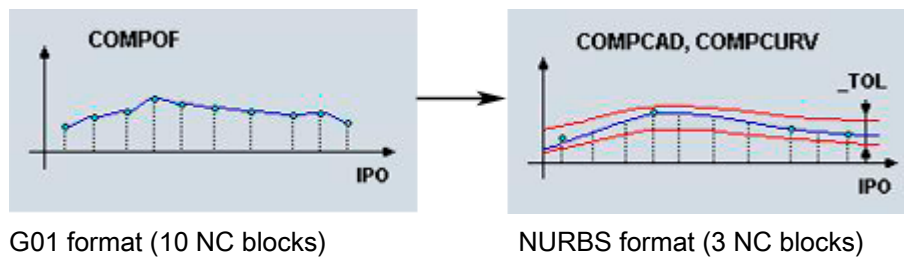

Highlights



- Higher machining speed through quasi-shortening of block change times
- Better surface smoothing through splines instead of linear blocks

7.2.3 Jerk limitation

Basic configuration

The control calculates a steady acceleration profile instead of jumps in acceleration. This enables jerk-free velocity characteristics for the involved path axes. The jerk limitation can also be directly activated in the part program with the »SOFT« NC language command.

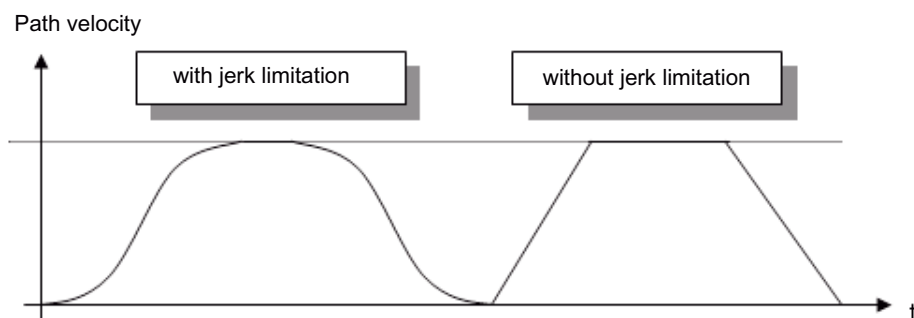

Highlights



- Longer machine lifespan through protection of the mechanical components
- Higher path accuracy through softer acceleration

7.2.4 Dynamic feedforward control

Basic configuration

Inaccuracies in the resulting workpiece contour due to following errors can practically be eliminated using dynamic feedforward control FFWON. The result is excellent machining precision even at high tool path feedrates. This is clarified with a circularity test on the machine.

Example:

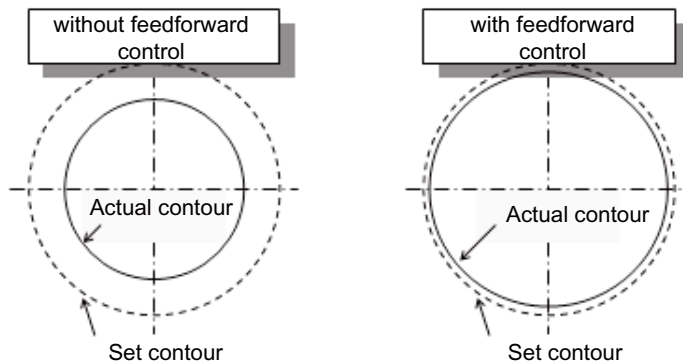

Highlight



- Higher path accuracy through compensation of contouring errors

7.2.5 Look Ahead

Basic configuration

The »Look Ahead« function is a means of optimizing the machining speed by »looking ahead« over a parameterizable number of traversing blocks. With tangential block transitions, the axis is accelerated and decelerated beyond block boundaries, so that no drops in velocity occur.

The SINUMERIK 802D sl plus allows up to 100 blocks Look Ahead.

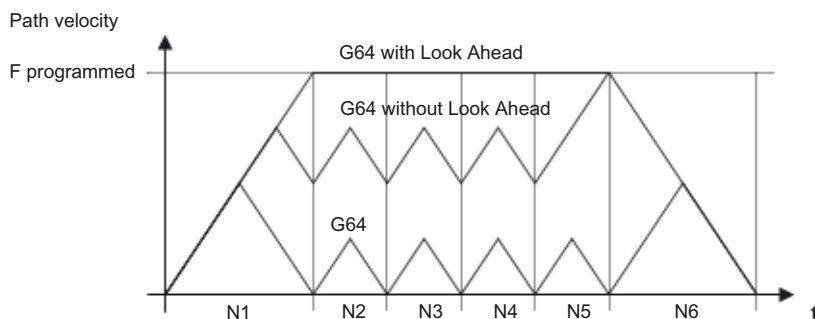

Highlight



- Shorter machining times through optimum velocity control

7.2.6 Block search

Basic configuration

A block search may be executed in machine status RESET, e.g. after a program interruption or to specifically return to machining. The program data are prepared in such a way that all relevant parameters (tool, work offsets, etc.) are available upon continuation of the program.

The following search variants are available:

- To the interruption point
- To any CNC block in the DIN/ISO programs
- To any subroutine levels in DIN/ISO programs

Highlights



- Time-saving and secure re-start at any program point, as no editing of the part program is required

Multilingual operator interface

8.1 Multilingual operator interface

Basic configuration

On the SINUMERIK 802D sl, the following languages are available on the operator interfaces. You can switch between these using a softkey.

- Chinese (simplified and traditional)
- German
- English
- Finnish
- French
- Italian
- Korean
- Dutch
- Polish
- Portuguese
- Romanian
- Russian
- Swedish
- Spanish
- Czech
- Turkish
- Hungarian



Highlight



- Operator interface in your language so that the CNC is easy to learn and safe to operate
- All languages are available on the control and can online be changed

Maintenance and diagnostics

9.1 Maintenance-free operation

Basic configuration

The SINUMERIK 802D sl offers maintenance-free operation:

- High reliability, because the SINUMERIK 802D sl has no hard disk, no battery and no fan
- Complete data backup on CF card, with all drive data

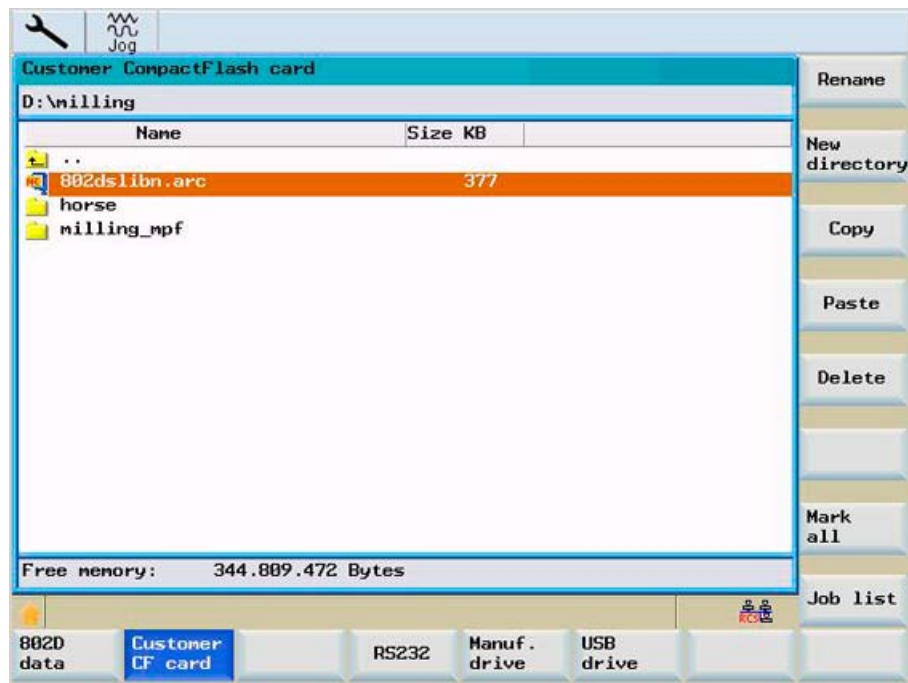

Highlight



- Highest machine availability thanks to reliable hardware

9.2 Diagnostics

Basic configuration

The SINUMERIK 802D sl offers diagnostic functions which are easy to use:

- Diagnostic functions, such as ladder display, are available for finding causes of malfunctions or a PLC program error.
- You can switch between two windows in ladder display (e.g. for cross-references).
- You are provided with the same display as on a PC, with zoom, find, symbol info, and cross-reference functions.
- For reasons of safety, it is not possible to edit the PLC program at the machine.

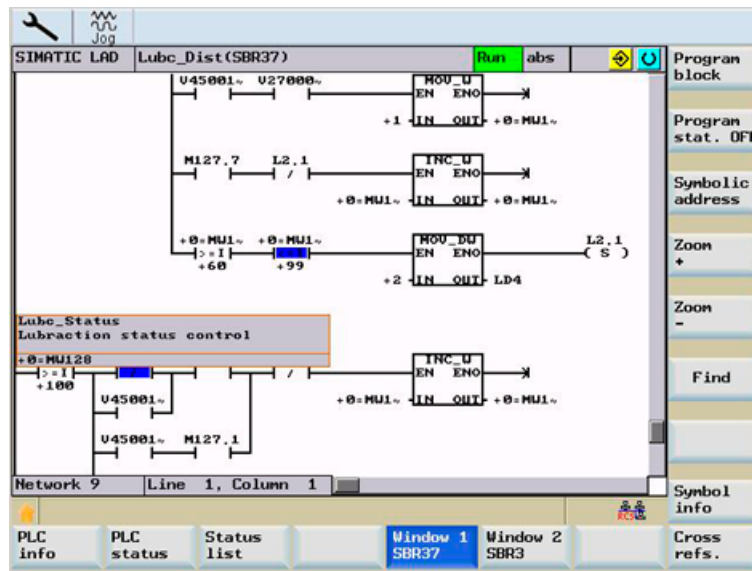

Highlight



- Highest machine availability thanks to modern diagnostic and troubleshooting tools

9.3 Remote diagnostics

- ☑ RCS802 on CD-ROM, included in scope of delivery
- ☑ Option: RCS802 remote diagnostics via Ethernet (PC license), only possible with SINUMERIK 802D sl pro

With the RCS802 software for PC, you can carry out remote diagnostics via the serial interface.

- With the SINUMERIK 802D sl pro, remote diagnostics can also be carried out via Ethernet (PC license).
- When connecting the PC to several machines, only one PC license is necessary for remote diagnostics via Ethernet.
- All machine tool controller diagnostic functions are also available in remote diagnostics.

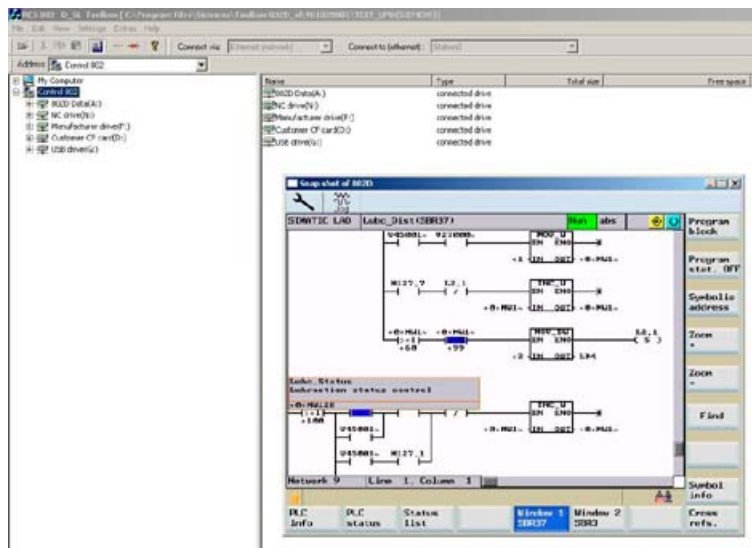

Highlight



- Shorter reaction times and lower service costs thanks to remote diagnostics

PC software

10.1 CAD reader for PC

Option: CAD reader for PC

You can convert contours and position patterns from PC-based DXF files into a format understandable to the controller with the PC software package "CAD Reader". You can edit contours via the controller.

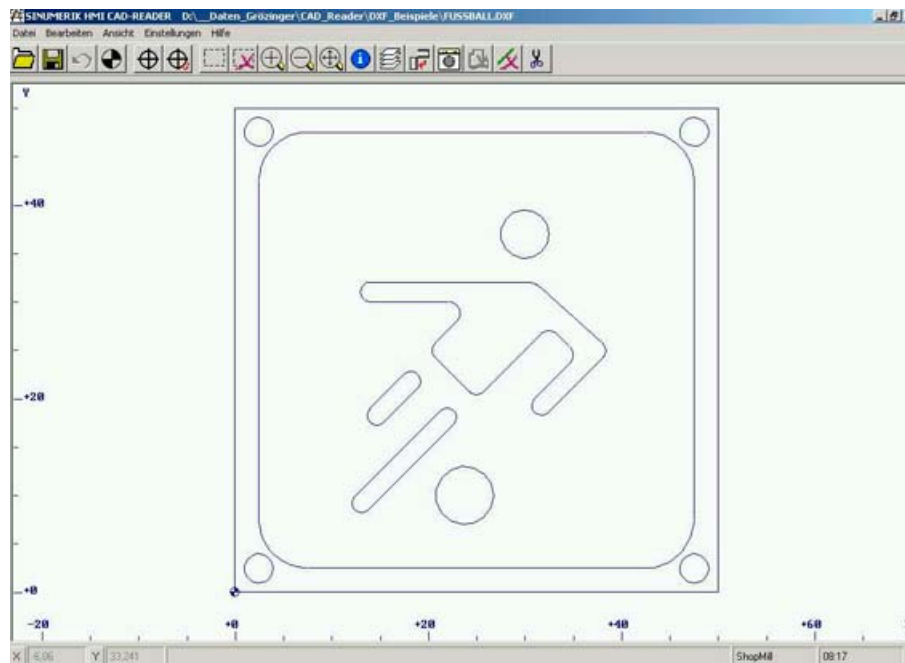

Highlight



- Save time by converting DXF files into contours and position patterns
- Work preparation and training at the PC without occupying the machine
- Editing via the controller possible at all times

10.2 SINUMERIK 802D on PC - SinuTrain

Option: SinuTrain 802D

Controller-identical PC system for work preparation and CNC training

- Complete range of functions of SINUMERIK 802D
- Networking of several student and trainer units possible



Highlight



- PC software for training and work preparation without occupying the machine

10.3 SINUMERIK 802D self-study CD

Option: SINUMERIK 802D self-study CD

Multimedia introduction to operation and programming with the SINUMERIK 802D

- Can be installed on PC
- Programming exercises with directed examples
- Available in three languages: German, English, and Chinese simplified



Highlight



- Graphically supported instruction software for beginners

Ordering data

Below is the information required for ordering:

| | |
|---|--------------------|
| SINUMERIK 802D sl plus | 6FC5370-0AA00-2AA0 |
| SINUMERIK 802D sl pro | 6FC5370-0AA00-3AA0 |
| Toolbox CD-ROM -> Already included with each 802D sl: with additional language files for the operator interface, RCS802 software, PLC programming tool, etc. | 6FC5810-0CY10-0YU8 |
| License disk for RCS802 remote diagnosis via Ethernet: (only possible with SINUMERIK 802D sl pro) | 6FC6000-6DA51-0AA0 |

Additional functions of SINUMERIK 802D sl pro compared to SINUMERIK 802D sl plus:

- COMPCAD and COMPCURV compressor for 3-axis mold-making
- Velocity control with Look Ahead increased from 50 blocks to 100 blocks
- USB stick pluggable on the rear of the PCU
- Connectivity via Ethernet
- Larger CNC user memory: Increased from 1MB to 3MB

Summary of unique selling points

The SINUMERIK 802D sl operator panel controller has the following selling points which make it stand out from the competition:

User-friendly operation

- Graphical support for setting up tools and workpiece zeros
- CompactFlash card, USB stick and Ethernet for unlimited user memory
- Graphical program simulation with zoom

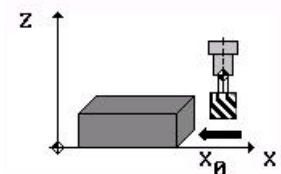

Time-saving programming

- Flexible G code programming
- Graphical support for technological machining cycles and contour editor as in ShopMill
- Complete user manual integrated

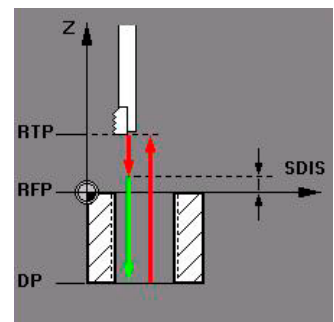

Increase in productivity

- 4th axis machining and mold-making
- Maintenance free operation and easy to diagnose
- Programming and training software for the PC



Index

8

802D on PC, 46

B

Block search, 37

C

CAD reader, 45
CNC keyboard, 10
CNC memory, 18
CompactFlash card, 18
Compressor, 33
Contour calculator, 26
Contour programming, 26
Cycles, 23

D

DXF converter, 45

E

Ethernet, 20

F

Feedforward control, 35
Field of application, 7
Flash card, 18

H

Handheld units, 10

L

Look Ahead, 36

M

Machine spectrum, 7
Mold-making, 31

N

Networking, 19, 20

O

Operator panel front, 10
Ordering data, 47

P

PC software, 45
Pocket calculator, 25
Program manager, 17

S

Serial data transfer, 19
SINUMERIK 802D sl, 9
SinuTrain, 46

T

TCP/IP, 20
Tool list, 14

U

Unique selling points, 49
USB stick, 19
User memory, 18

V

Velocity control, 34

W

Work offsets, 11

